



**Commercial parasols for catering, hospitality and leisure**

# Malaga Parasol Data sheet – dimensions 2022

MORTON COMMERCIAL PARASOLS

Unit 1, Horseferry Bridge, Cirencester Road, Little Witcombe, Gloucester GL3 4SU, United Kingdom

T: +44 (0)1452 865260

info@mortonparasols.com      www.mortonparasols.com

Registered in England, company no.5493061    VAT no.862 2599 01

# Index

| Page |  | Page |   |
|------|--|------|---|
| 1    | 2.5m Square with an "in ground" anchor or deck plate | 9    | 3.5m Octagonal with an "in ground" anchor or deck plate |
| 2    | 2.5m Square on a pedestal with feet                  | 10   | 3.5m Octagonal on a pedestal with feet                  |
| 3    | 2.5m Square on a pedestal with 50mm wheels           | 11   | 3.5m Octagonal on a pedestal with 50mm wheels           |
| 4    | 2.5m Square on a pedestal with 75mm wheels           | 12   | 3.5m Octagonal on a pedestal with 75mm wheels           |
| 5    | 3m Square with an "in ground" anchor or deck plate   | 13   | 4.2 Octagonal with an "in ground" anchor or deck plate  |
| 6    | 3m Square on a pedestal with feet                    | 14   | 4.2m Octagonal on a pedestal with feet                  |
| 7    | 3m Square on a pedestal with 50mm wheels             | 15   | 4.2m Octagonal on a pedestal with 50mm wheels           |
| 8    | 3m Square on a pedestal with 75mm wheels             | 16   | 4.2m Octagonal on a pedestal with 75mm wheels           |

# Malaga Parasol Data *2.5m Square with an "in ground" anchor or deck plate*

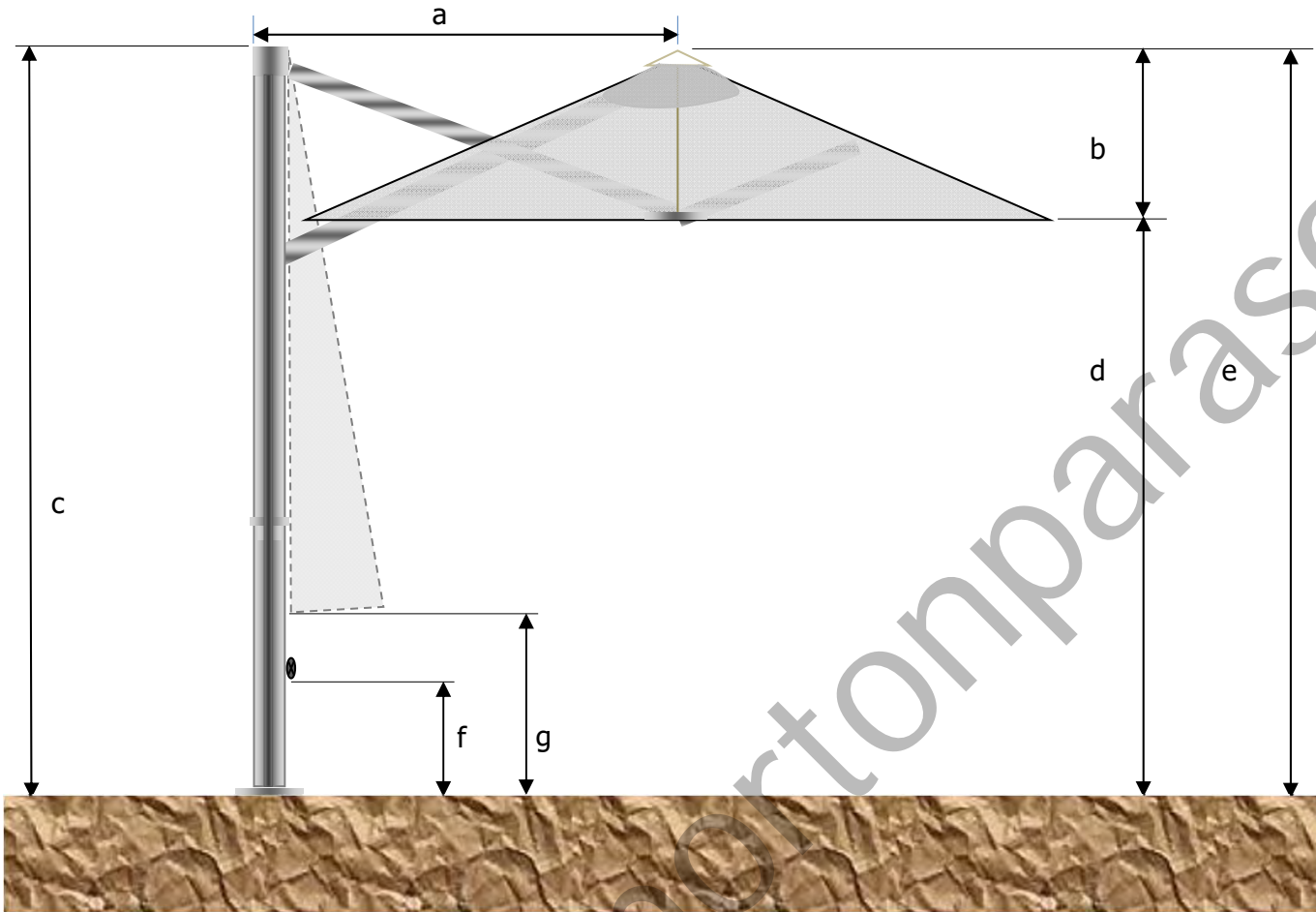

Mast length: 260cm

Dimensions in cm

(Tolerance of +/- 5%)

|   |                                      |     |
|---|--------------------------------------|-----|
| a | Rear of mast to canopy centre        | 190 |
| b | Canopy depth                         | 70  |
| c | Overall height                       | 264 |
| d | Head room height                     | 203 |
| e | Apex of canopy to floor              | 273 |
| f | Bottom edge of sliding knob to floor | 39  |
| g | Closed floor clearance               | 67  |

## Morton Marine & Commercial Parasols

Unit 1, Horseferry Bridge, Cirencester Road, Little Witcombe, Gloucester, GL3 4SU, United Kingdom

T: +44 (0)1452 865260 E: info@mortonparasols.com

W: www.mortonparasols.com (Commercial) W: mortonparasols.co.uk (Residential) W: marineparasols.co.uk (Marine)

# Malaga Parasol Data *2.5m Square on a pedestal with feet*



Mast length: 260cm

Dimensions in cm

(Tolerance of +/- 5%)

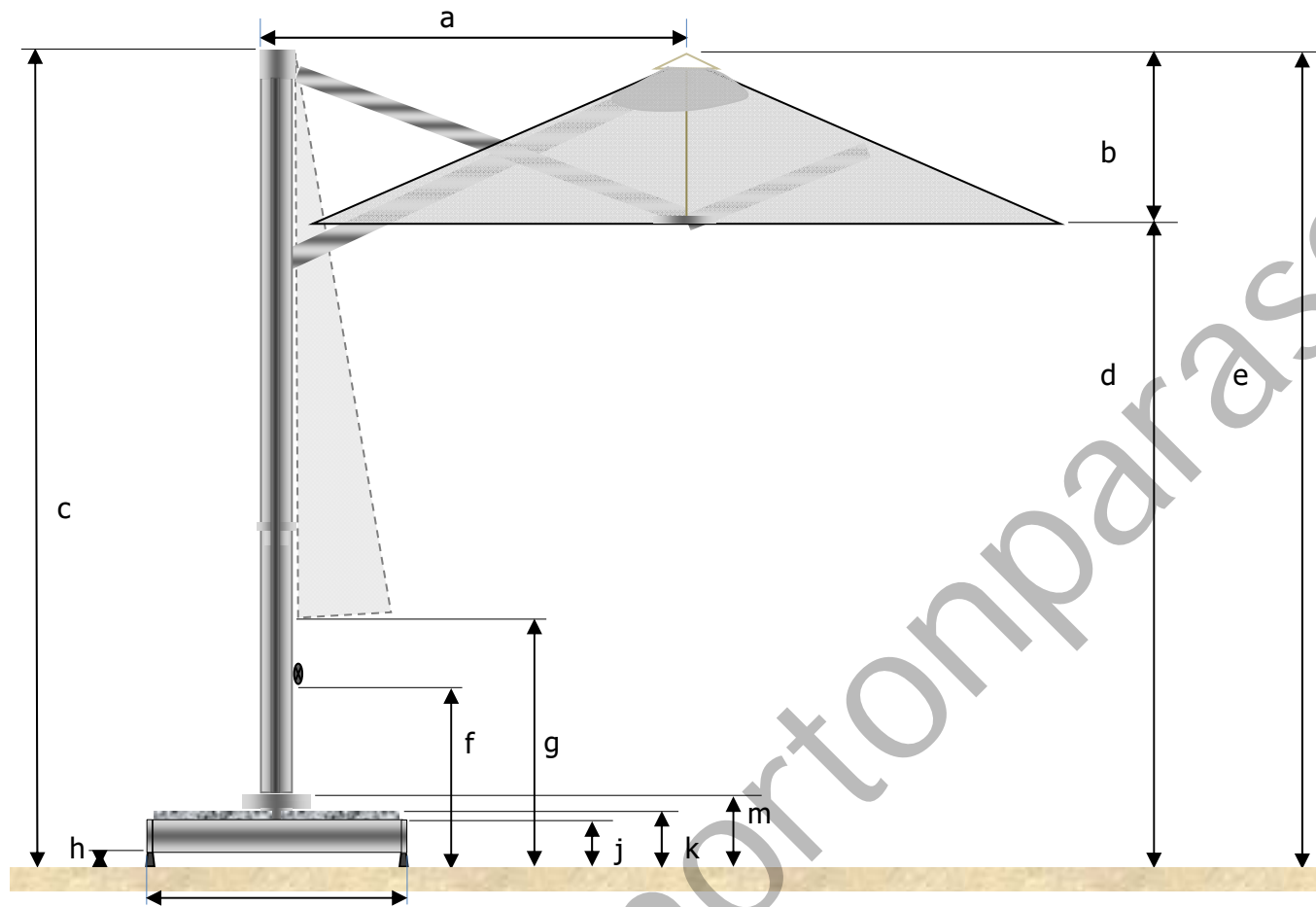

|   |                                      |            |
|---|--------------------------------------|------------|
| a | Rear of mast to canopy centre        | 190        |
| b | Canopy depth                         | 70         |
| c | Overall height                       | 278        |
| d | Head room height                     | 217        |
| e | Apex of canopy to floor              | 273        |
| f | Bottom edge of sliding knob to floor | 53         |
| g | Closed floor clearance               | 81         |
| h | Underside of pedestal to floor       | 1-5 to 3.5 |
| j | Top edge of pedestal to floor        | 12         |
| k | Top of the top layer slab to floor   | 19.5       |
| m | Top of flange to floor               | 16         |
| n | Width of pedestal (inc. welded lugs) | 105        |

## Morton Marine & Commercial Parasols

Unit 1, Horseferry Bridge, Cirencester Road,  
Little Witcombe, Gloucester, GL3 4SU, UK

T: +44 (0)1452 865260

E: info@mortonparasols.com

W: www.mortonparasols.com (Commercial)

W: mortonparasols.co.uk (Residential)

W: marineparasols.co.uk (Marine)

page

2

***If in doubt - ask***

# Malaga Parasol Data *2.5m Square on a pedestal + 50mm wheels*



Mast length: 260cm

Dimensions in cm

(Tolerance of +/- 5%)

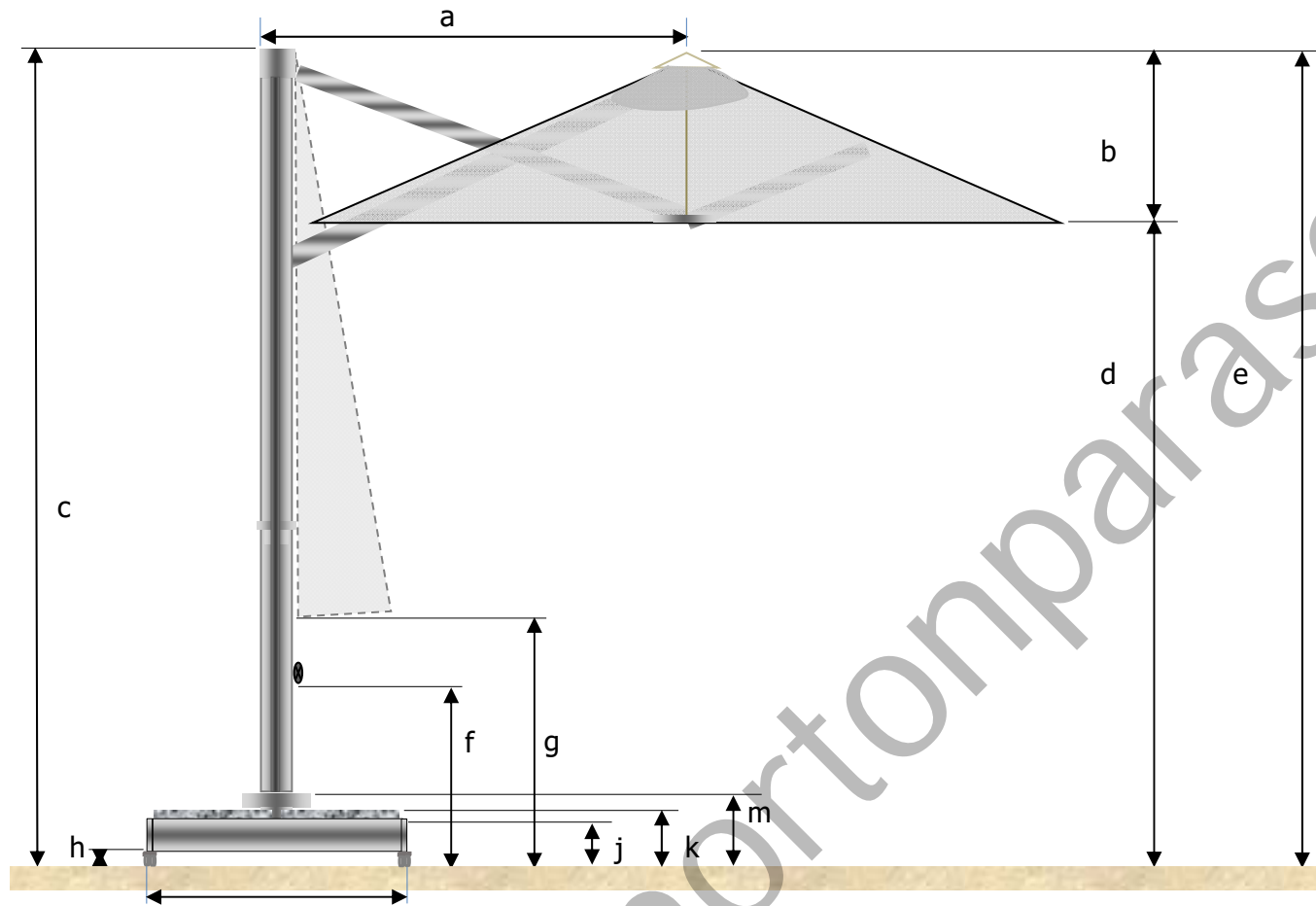

|   |                                      |      |
|---|--------------------------------------|------|
| a | Rear of mast to canopy centre        | 190  |
| b | Canopy depth                         | 70   |
| c | Overall height                       | 283  |
| d | Head room height                     | 222  |
| e | Apex of canopy to floor              | 278  |
| f | Bottom edge of sliding knob to floor | 58   |
| g | Closed floor clearance               | 86   |
| h | Underside of pedestal to floor       | 7    |
| j | Top edge of pedestal to floor        | 12   |
| k | Top of the top layer slab to floor   | 19.5 |
| m | Top of flange to floor               | 16   |
| n | Width of pedestal (inc. welded lugs) | 105  |

### Morton Marine & Commercial Parasols

Unit 1, Horseferry Bridge, Cirencester Road,  
Little Witcombe, Gloucester, GL3 4SU, UK

T: +44 (0)1452 865260

E: info@mortonparasols.com

W: www.mortonparasols.com (Commercial)

W: mortonparasols.co.uk (Residential)

W: marineparasols.co.uk (Marine)

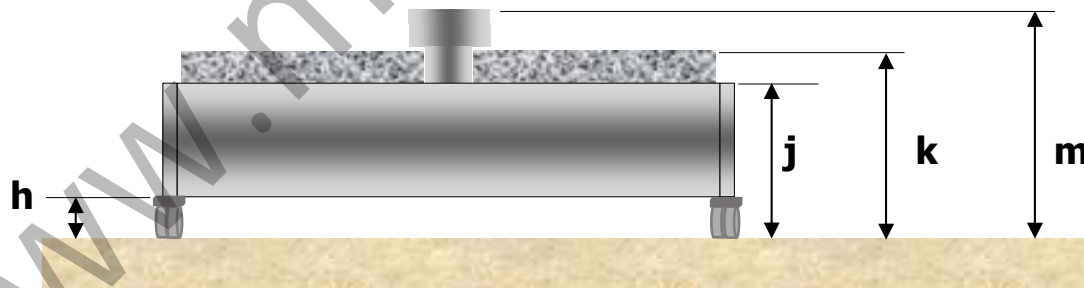
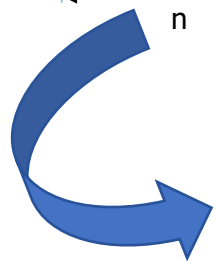

page

3

***If in doubt - ask***

# Malaga Parasol Data *2.5m Square on a pedestal + 75mm wheels*



Mast length: 260cm

Dimensions in cm

(Tolerance of +/- 5%)

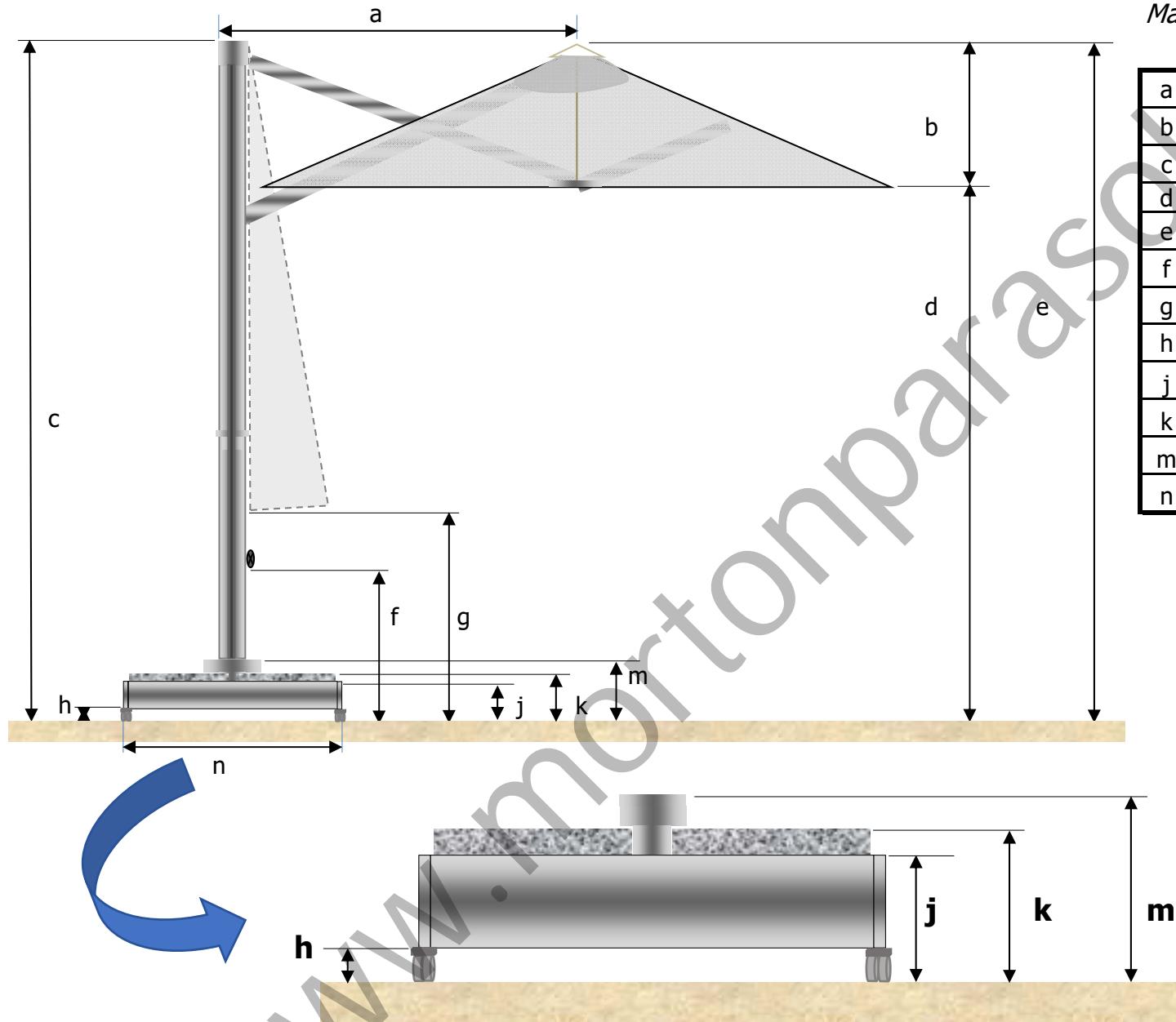

|   |                                      |      |
|---|--------------------------------------|------|
| a | Rear of mast to canopy centre        | 190  |
| b | Canopy depth                         | 70   |
| c | Overall height                       | 286  |
| d | Head room height                     | 225  |
| e | Apex of canopy to floor              | 281  |
| f | Bottom edge of sliding knob to floor | 61   |
| g | Closed floor clearance               | 89   |
| h | Underside of pedestal to floor       | 10   |
| j | Top edge of pedestal to floor        | 12   |
| k | Top of the top layer slab to floor   | 19.5 |
| m | Top of flange to floor               | 16   |
| n | Width of pedestal (inc. welded lugs) | 105  |

## Morton Marine & Commercial Parasols

Unit 1, Horseferry Bridge, Cirencester Road,  
Little Witcombe, Gloucester, GL3 4SU, UK

T: +44 (0)1452 865260

E: info@mortonparasols.com

W: www.mortonparasols.com (Commercial)

W: mortonparasols.co.uk (Residential)

W: marineparasols.co.uk (Marine)

page

4

***If in doubt - ask***

# Malaga Parasol Data *3m Square with an "in ground" anchor or deck plate*

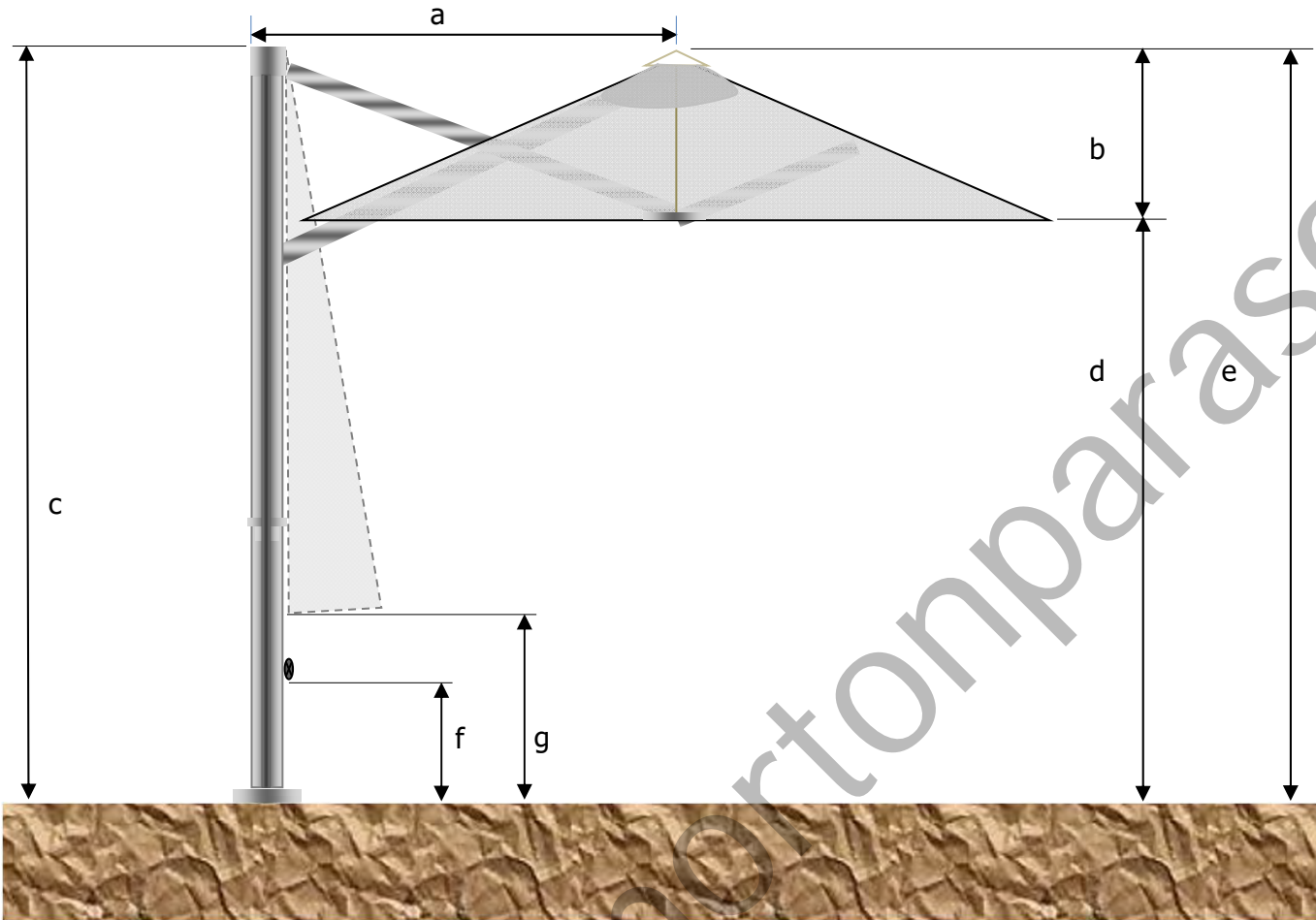

Mast length: 285cm

Dimensions in cm

(Tolerance of +/- 5%)

|   |                                      |     |
|---|--------------------------------------|-----|
| a | Rear of mast to canopy centre        | 227 |
| b | Canopy depth                         | 70  |
| c | Overall height                       | 303 |
| d | Head room height                     | 240 |
| e | Apex of canopy to floor              | 289 |
| f | Bottom edge of sliding knob to floor | 52  |
| g | Closed floor clearance               | 80  |

## Morton Marine & Commercial Parasols

Unit 1, Horseferry Bridge, Cirencester Road, Little Witcombe, Gloucester, GL3 4SU, United Kingdom

T: +44 (0)1452 865260 E: info@mortonparasols.com

W: www.mortonparasols.com (Commercial) W: mortonparasols.co.uk (Residential) W: marineparasols.co.uk (Marine)

# Malaga Parasol Data *3m Square on a pedestal with feet*



Mast length: 285cm

Dimensions in cm

(Tolerance of +/- 5%)

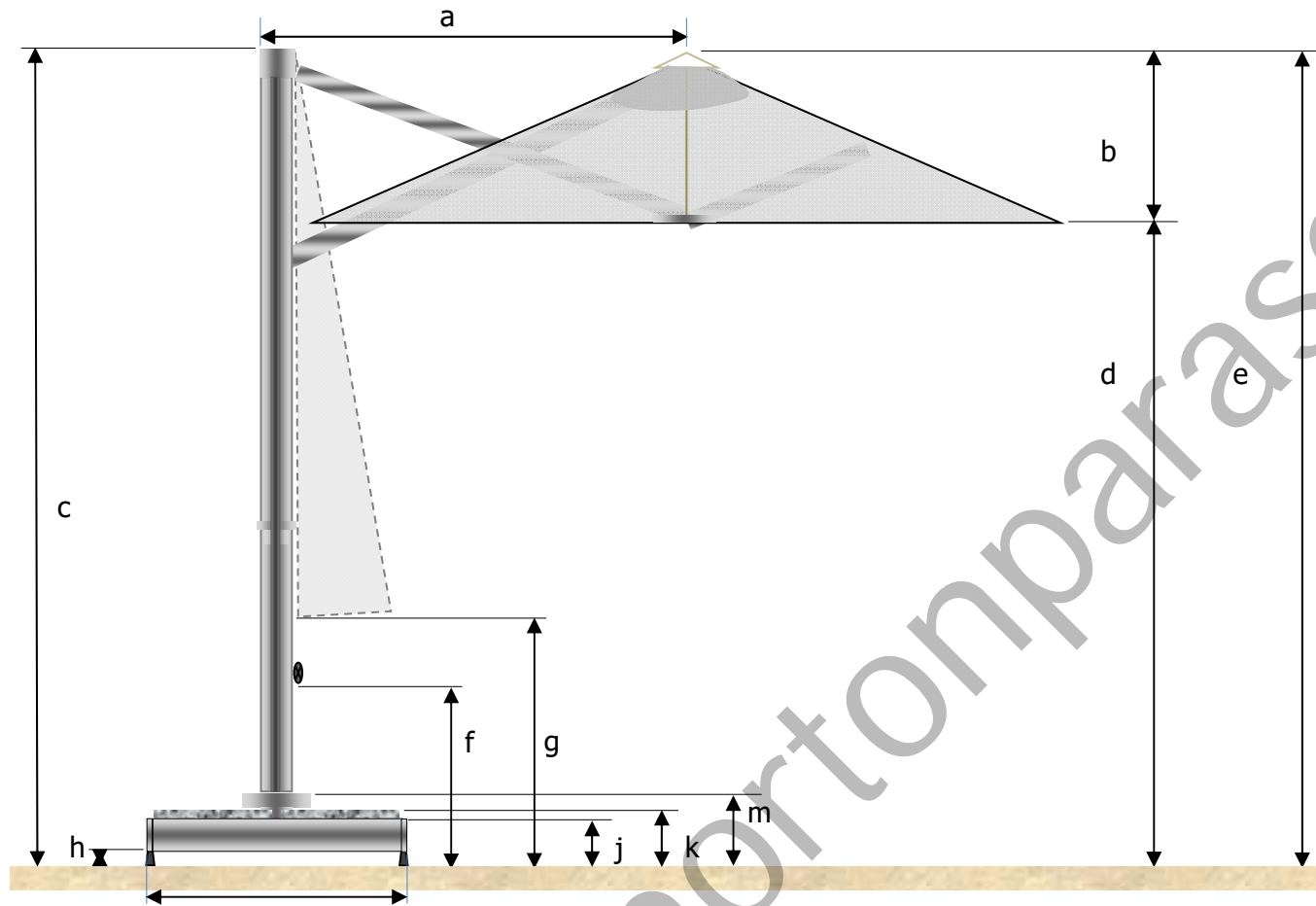

|   |                                      |            |
|---|--------------------------------------|------------|
| a | Rear of mast to canopy centre        | 227        |
| b | Canopy depth                         | 70         |
| c | Overall height                       | 296        |
| d | Head room height                     | 232        |
| e | Apex of canopy to floor              | 281        |
| f | Bottom edge of sliding knob to floor | 40         |
| g | Closed floor clearance               | 72         |
| h | Underside of pedestal to floor       | 1-5 to 3.5 |
| j | Top edge of pedestal to floor        | 12         |
| k | Top of the top layer slab to floor   | 19.5       |
| m | Top of flange to floor               | 16         |
| n | Width of pedestal (inc. welded lugs) | 105        |

## Morton Marine & Commercial Parasols

Unit 1, Horseferry Bridge, Cirencester Road,  
Little Witcombe, Gloucester, GL3 4SU, UK

T: +44 (0)1452 865260

E: info@mortonparasols.com

W: www.mortonparasols.com (Commercial)

W: mortonparasols.co.uk (Residential)

W: marineparasols.co.uk (Marine)

page  
6

***If in doubt - ask***



# Malaga Parasol Data *3m Square on a pedestal + 50mm wheels*



Mast length: 285cm

Dimensions in cm

(Tolerance of +/- 5%)

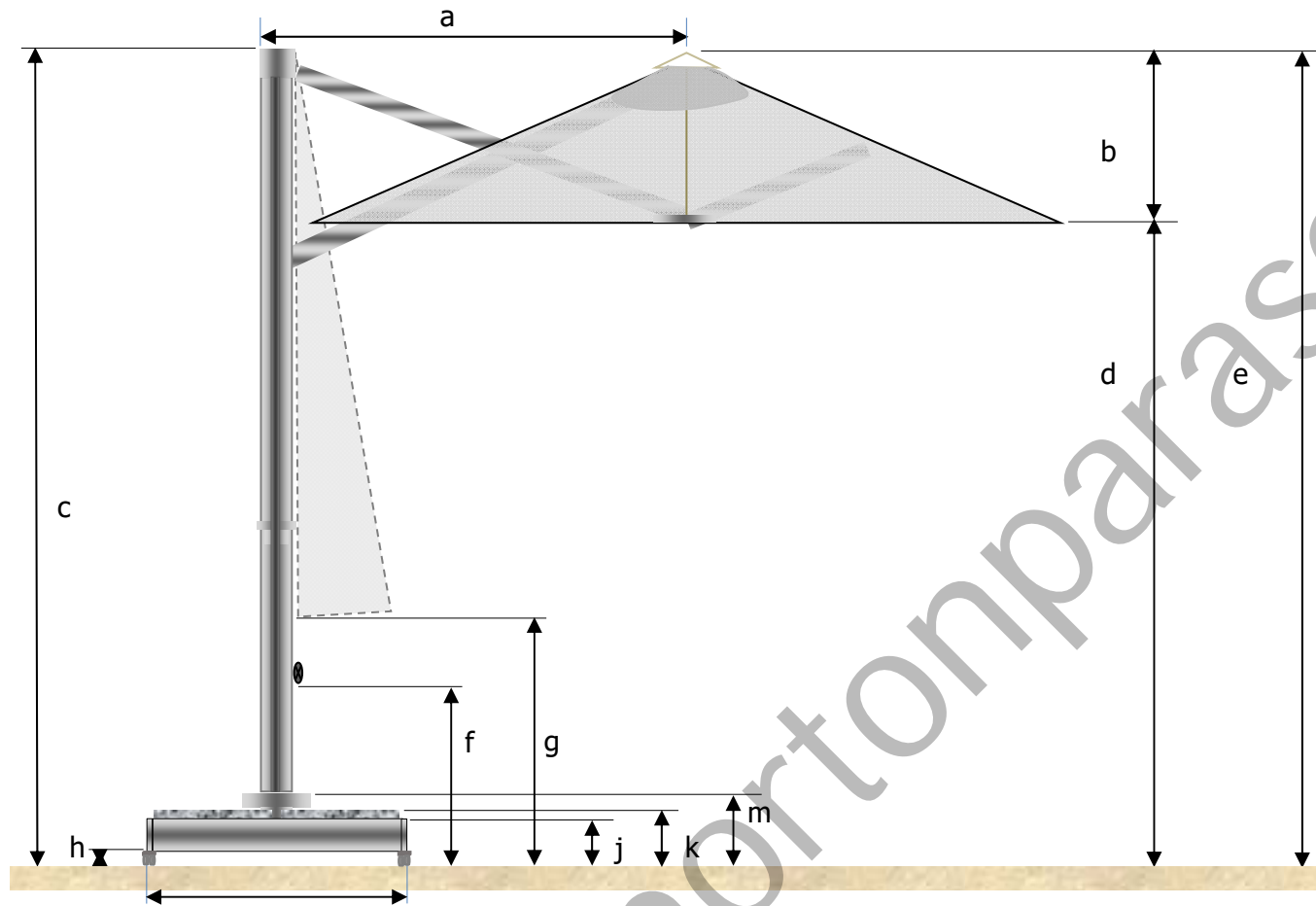

|   |                                      |      |
|---|--------------------------------------|------|
| a | Rear of mast to canopy centre        | 227  |
| b | Canopy depth                         | 70   |
| c | Overall height                       | 299  |
| d | Head room height                     | 237  |
| e | Apex of canopy to floor              | 286  |
| f | Bottom edge of sliding knob to floor | 44   |
| g | Closed floor clearance               | 77   |
| h | Underside of pedestal to floor       | 7    |
| j | Top edge of pedestal to floor        | 17   |
| k | Top of the top layer slab to floor   | 24.5 |
| m | Top of flange to floor               | 21   |
| n | Width of pedestal (inc. welded lugs) | 105  |

## Morton Marine & Commercial Parasols

Unit 1, Horseferry Bridge, Cirencester Road,  
Little Witcombe, Gloucester, GL3 4SU, UK

T: +44 (0)1452 865260

E: info@mortonparasols.com

W: www.mortonparasols.com (Commercial)

W: mortonparasols.co.uk (Residential)

W: marineparasols.co.uk (Marine)

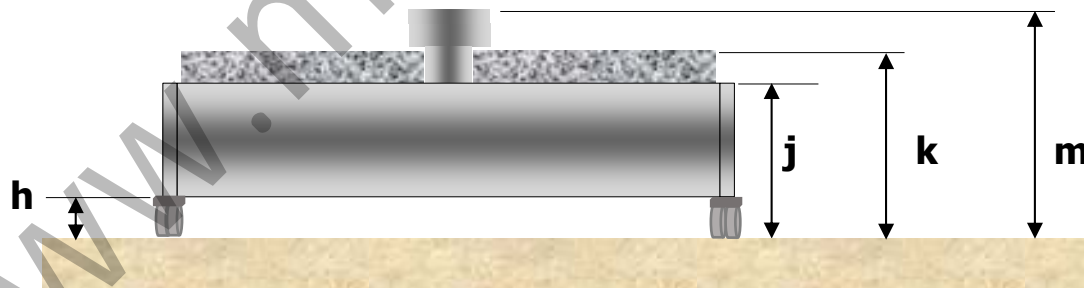
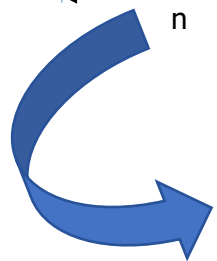

page

7

***If in doubt - ask***

# Malaga Parasol Data *3m Square on a pedestal + 75mm wheels*



Mast length: 285cm

Dimensions in cm

(Tolerance of +/- 5%)

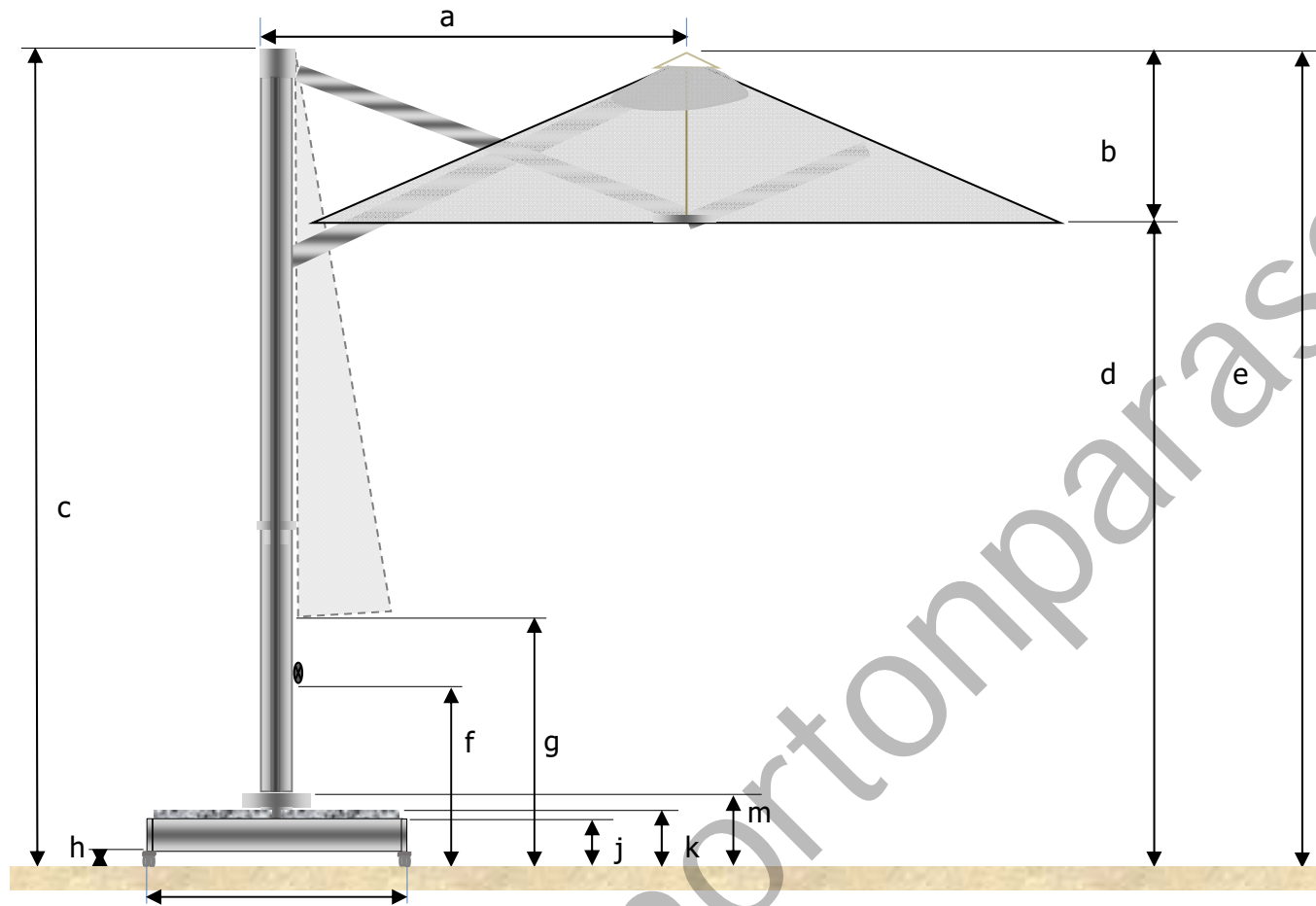

|   |                                      |      |
|---|--------------------------------------|------|
| a | Rear of mast to canopy centre        | 227  |
| b | Canopy depth                         | 70   |
| c | Overall height                       | 302  |
| d | Head room height                     | 240  |
| e | Apex of canopy to floor              | 289  |
| f | Bottom edge of sliding knob to floor | 48   |
| g | Closed floor clearance               | 80   |
| h | Underside of pedestal to floor       | 10   |
| j | Top edge of pedestal to floor        | 20   |
| k | Top of the top layer slab to floor   | 27.5 |
| m | Top of flange to floor               | 24   |
| n | Width of pedestal (inc. welded lugs) | 105  |

## Morton Marine & Commercial Parasols

Unit 1, Horseferry Bridge, Cirencester Road,  
Little Witcombe, Gloucester, GL3 4SU, UK

T: +44 (0)1452 865260

E: info@mortonparasols.com

W: www.mortonparasols.com (Commercial)

W: mortonparasols.co.uk (Residential)

W: marineparasols.co.uk (Marine)

page

8

***If in doubt - ask***

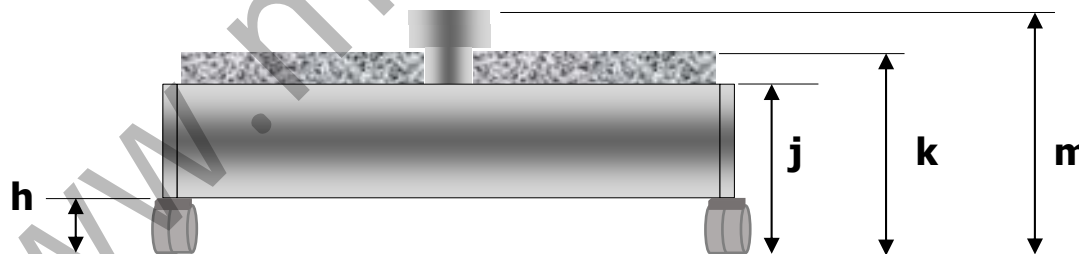

# Malaga Parasol Data

*3.5m Octagonal with an "in ground" anchor or deck plate*

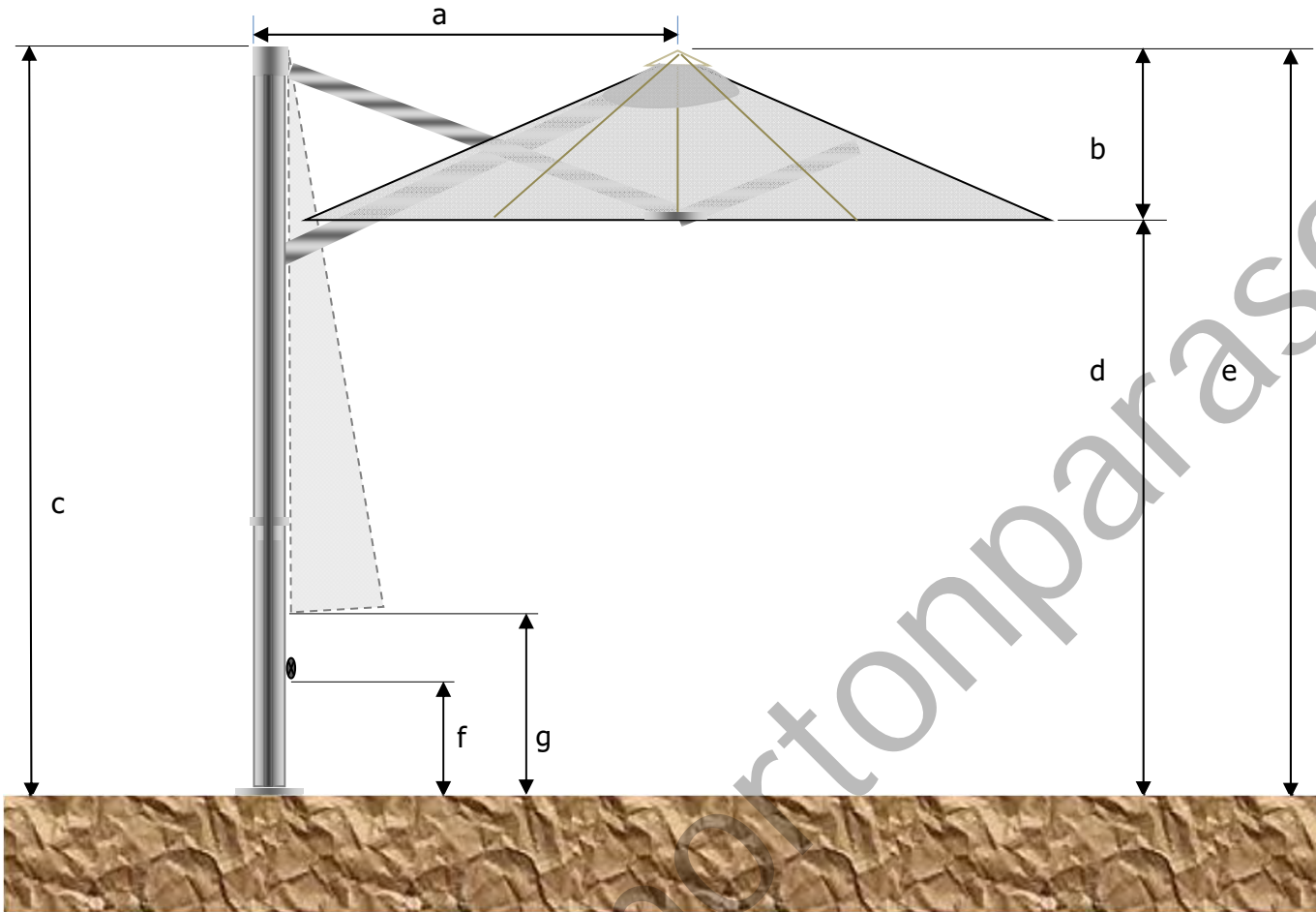

*Mast length: 260cm*

Dimensions in cm

(Tolerance of +/- 5%)

|   |                                      |     |
|---|--------------------------------------|-----|
| a | Rear of mast to canopy centre        | 190 |
| b | Canopy depth                         | 70  |
| c | Overall height                       | 264 |
| d | Head room height                     | 203 |
| e | Apex of canopy to floor              | 273 |
| f | Bottom edge of sliding knob to floor | 39  |
| g | Closed floor clearance               | 67  |

## Morton Marine & Commercial Parasols

Unit 1, Horseferry Bridge, Cirencester Road, Little Witcombe, Gloucester, GL3 4SU, United Kingdom

T: +44 (0)1452 865260 E: info@mortonparasols.com

W: www.mortonparasols.com (Commercial) W: mortonparasols.co.uk (Residential) W: marineparasols.co.uk (Marine)

# Malaga Parasol Data *3.5m Octagonal on a pedestal with feet*



Mast length: 260cm

Dimensions in cm

(Tolerance of +/- 5%)

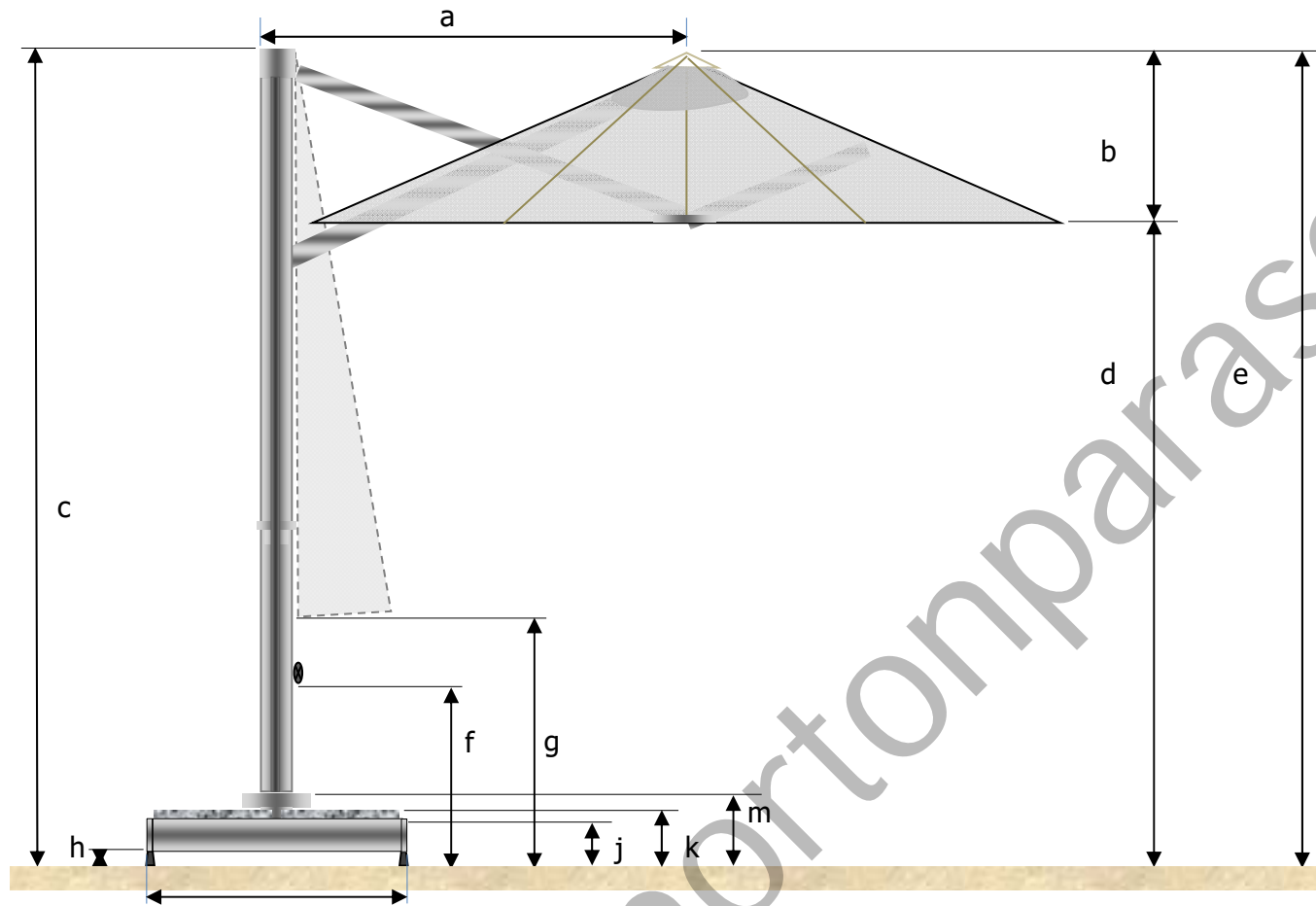

|   |                                      |            |
|---|--------------------------------------|------------|
| a | Rear of mast to canopy centre        | 190        |
| b | Canopy depth                         | 70         |
| c | Overall height                       | 278        |
| d | Head room height                     | 217        |
| e | Apex of canopy to floor              | 273        |
| f | Bottom edge of sliding knob to floor | 53         |
| g | Closed floor clearance               | 81         |
| h | Underside of pedestal to floor       | 1-5 to 3.5 |
| j | Top edge of pedestal to floor        | 12         |
| k | Top of the top layer slab to floor   | 19.5       |
| m | Top of flange to floor               | 16         |
| n | Width of pedestal (inc. welded lugs) | 105        |

## Morton Marine & Commercial Parasols

Unit 1, Horseferry Bridge, Cirencester Road,  
Little Witcombe, Gloucester, GL3 4SU, UK

T: +44 (0)1452 865260

E: info@mortonparasols.com

W: www.mortonparasols.com (Commercial)

W: mortonparasols.co.uk (Residential)

W: marineparasols.co.uk (Marine)

page

10

***If in doubt - ask***

# Malaga Parasol Data *3.5m Octagonal on a pedestal + 50mm wheels*



Mast length: 260cm

Dimensions in cm

(Tolerance of +/- 5%)

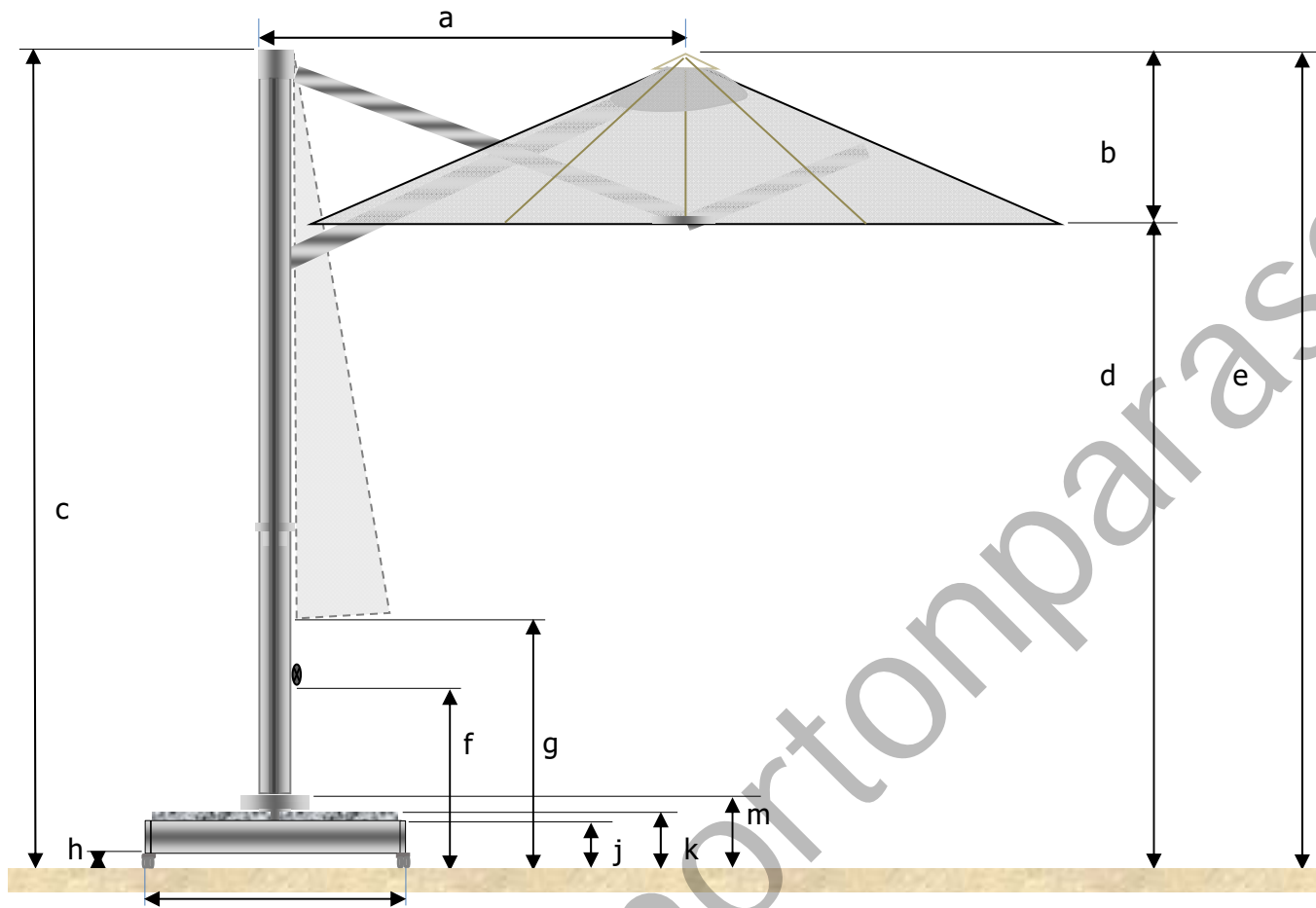

|   |                                      |      |
|---|--------------------------------------|------|
| a | Rear of mast to canopy centre        | 190  |
| b | Canopy depth                         | 70   |
| c | Overall height                       | 283  |
| d | Head room height                     | 222  |
| e | Apex of canopy to floor              | 278  |
| f | Bottom edge of sliding knob to floor | 58   |
| g | Closed floor clearance               | 86   |
| h | Underside of pedestal to floor       | 7    |
| j | Top edge of pedestal to floor        | 12   |
| k | Top of the top layer slab to floor   | 19.5 |
| m | Top of flange to floor               | 16   |
| n | Width of pedestal (inc. welded lugs) | 105  |

## Morton Marine & Commercial Parasols

Unit 1, Horseferry Bridge, Cirencester Road,  
Little Witcombe, Gloucester, GL3 4SU, UK

T: +44 (0)1452 865260

E: info@mortonparasols.com

W: www.mortonparasols.com (Commercial)

W: mortonparasols.co.uk (Residential)

W: marineparasols.co.uk (Marine)

page

11

***If in doubt - ask***

# Malaga Parasol Data *3.5m Octagonal on a pedestal + 75mm wheels*



Mast length: 260cm

Dimensions in cm

(Tolerance of +/- 5%)

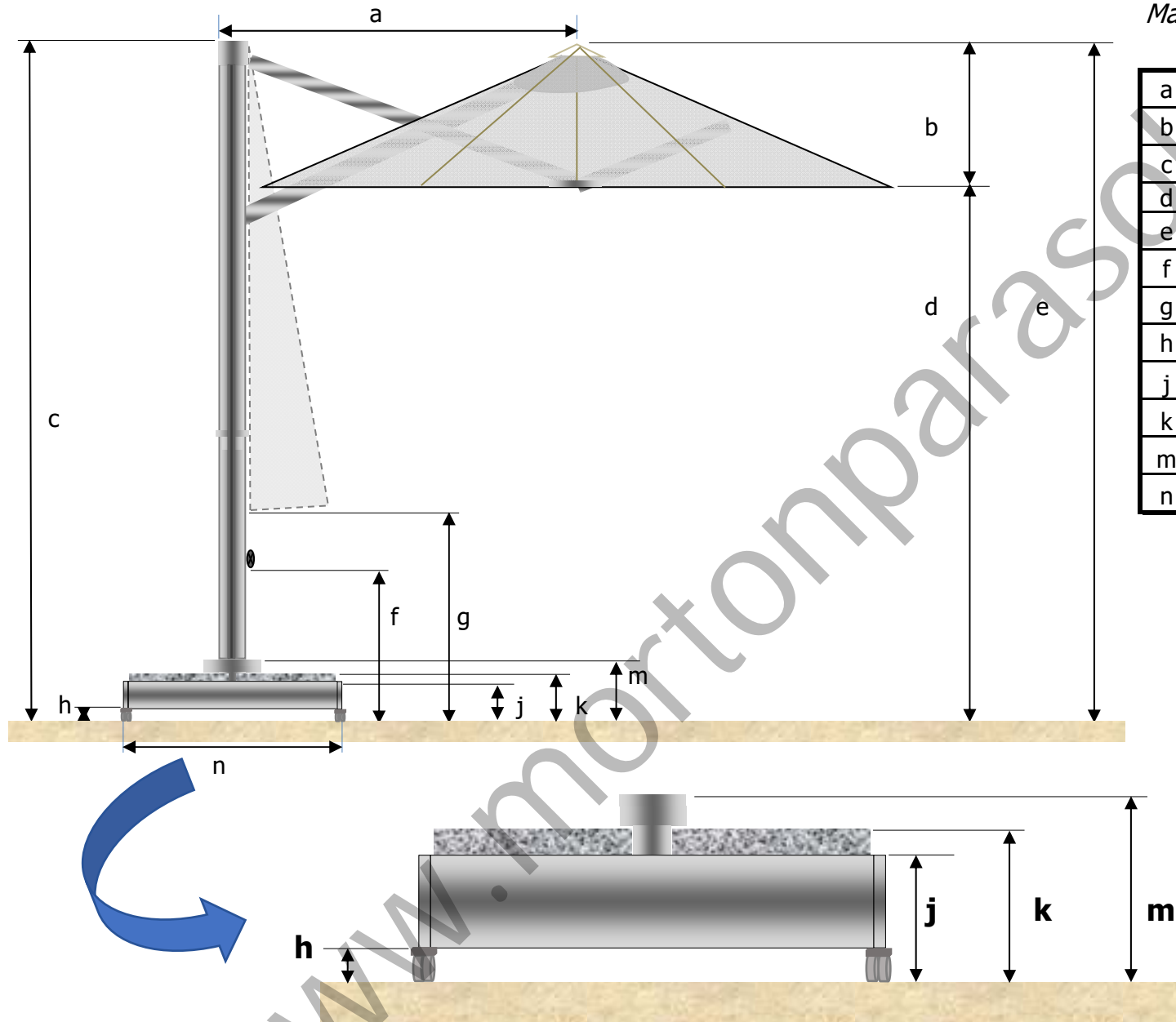

|   |                                      |      |
|---|--------------------------------------|------|
| a | Rear of mast to canopy centre        | 190  |
| b | Canopy depth                         | 70   |
| c | Overall height                       | 286  |
| d | Head room height                     | 225  |
| e | Apex of canopy to floor              | 281  |
| f | Bottom edge of sliding knob to floor | 61   |
| g | Closed floor clearance               | 89   |
| h | Underside of pedestal to floor       | 10   |
| j | Top edge of pedestal to floor        | 12   |
| k | Top of the top layer slab to floor   | 19.5 |
| m | Top of flange to floor               | 16   |
| n | Width of pedestal (inc. welded lugs) | 105  |

## Morton Marine & Commercial Parasols

Unit 1, Horseferry Bridge, Cirencester Road,  
Little Witcombe, Gloucester, GL3 4SU, UK

T: +44 (0)1452 865260

E: info@mortonparasols.com

W: www.mortonparasols.com (Commercial)

W: mortonparasols.co.uk (Residential)

W: marineparasols.co.uk (Marine)

page

12

***If in doubt - ask***

# Malaga Parasol Data

4.2m Octagonal with an "in ground" anchor or deck plate

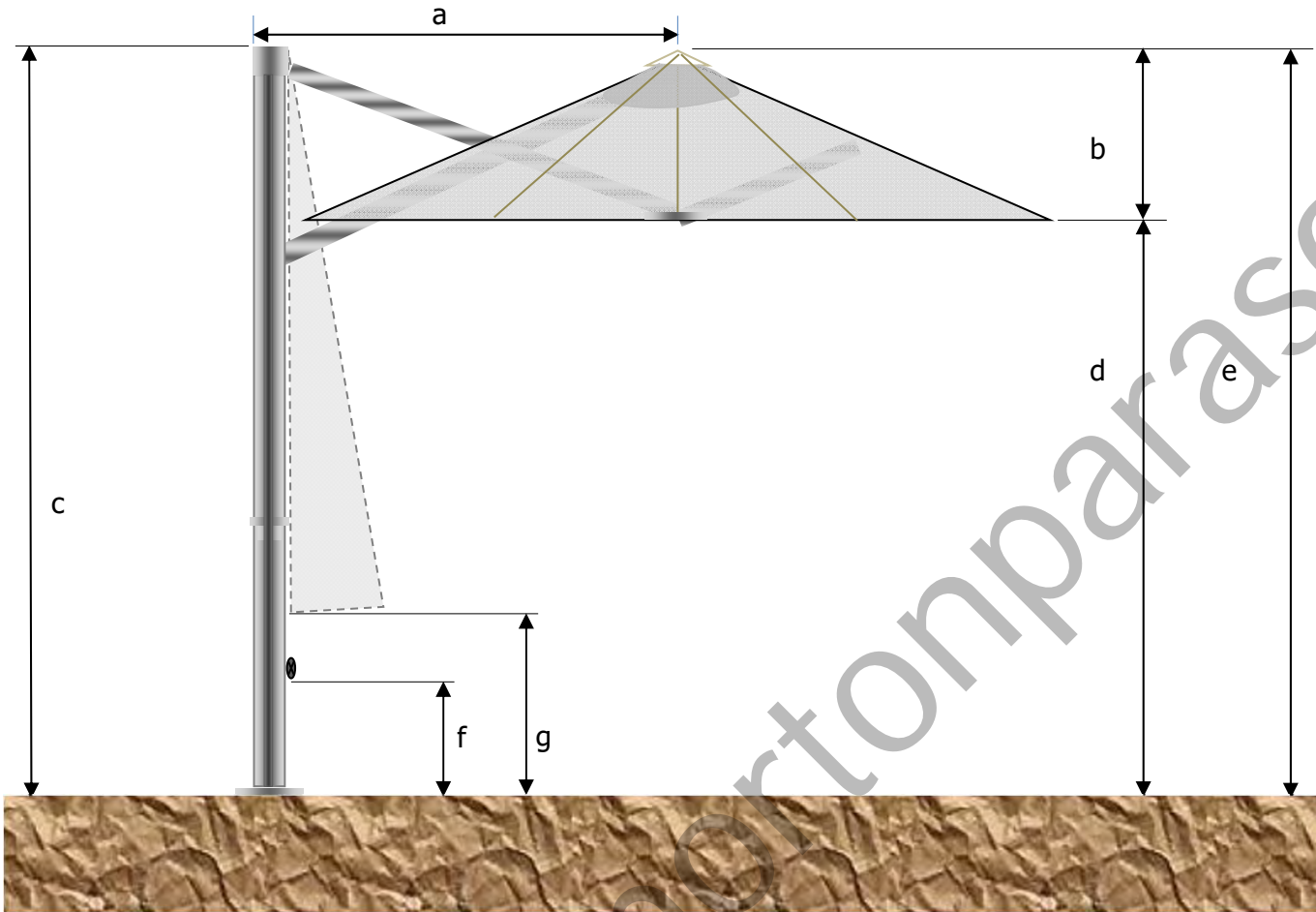

Mast length: 260cm

Dimensions in cm

(Tolerance of +/- 5%)

|   |                                      |     |
|---|--------------------------------------|-----|
| a | Rear of mast to canopy centre        | 227 |
| b | Canopy depth                         | 70  |
| c | Overall height                       | 303 |
| d | Head room height                     | 240 |
| e | Apex of canopy to floor              | 289 |
| f | Bottom edge of sliding knob to floor | 52  |
| g | Closed floor clearance               | 80  |

## Morton Marine & Commercial Parasols

Unit 1, Horseferry Bridge, Cirencester Road, Little Witcombe, Gloucester, GL3 4SU, United Kingdom

T: +44 (0)1452 865260 E: info@mortonparasols.com

W: www.mortonparasols.com (Commercial) W: mortonparasols.co.uk (Residential) W: marineparasols.co.uk (Marine)

page

13

***If in doubt - ask***

# Malaga Parasol Data *4.2m Octagonal on a pedestal with feet*



Mast length: 260cm

Dimensions in cm

(Tolerance of +/- 5%)

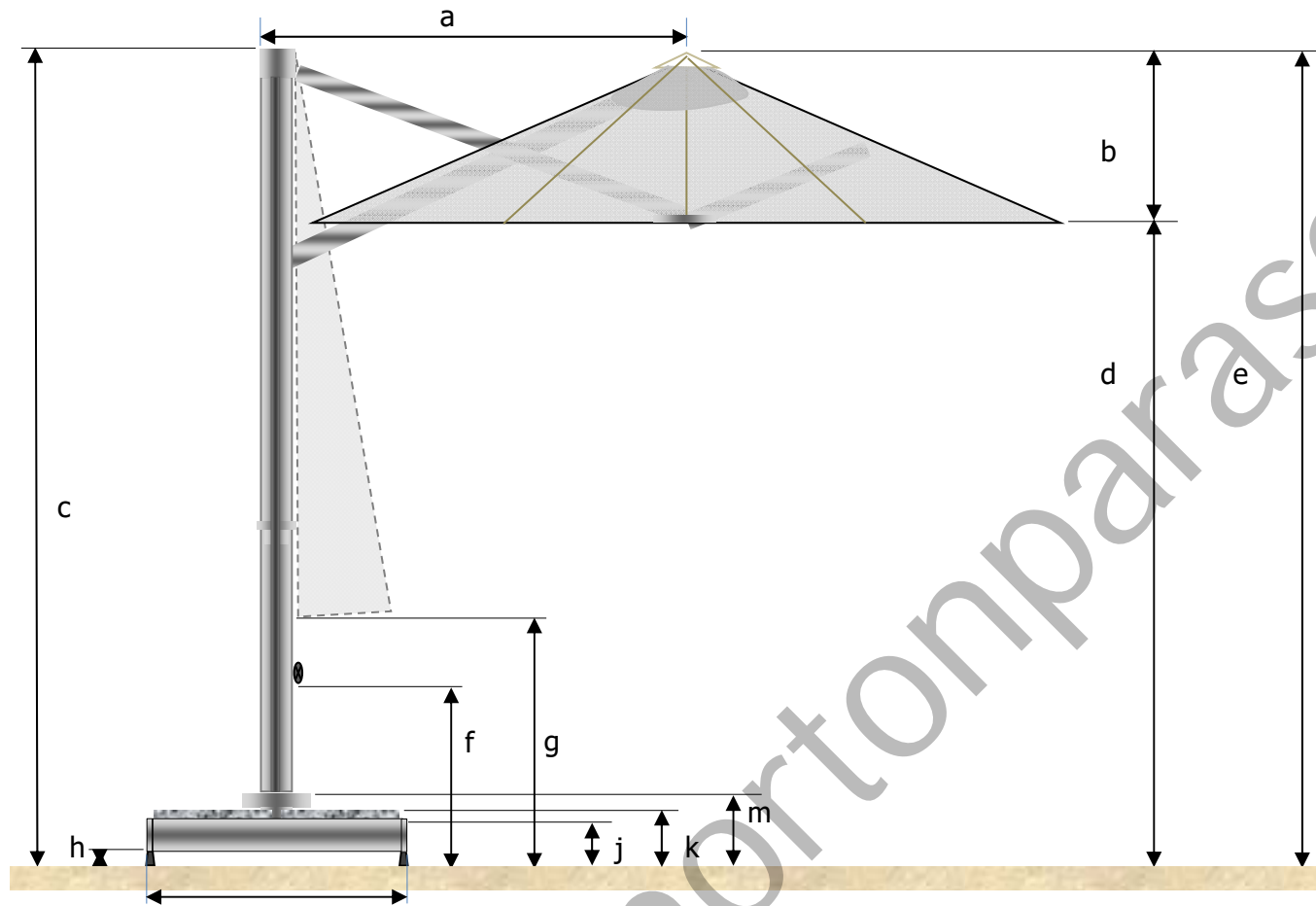

|   |                                      |            |
|---|--------------------------------------|------------|
| a | Rear of mast to canopy centre        | 227        |
| b | Canopy depth                         | 70         |
| c | Overall height                       | 296        |
| d | Head room height                     | 232        |
| e | Apex of canopy to floor              | 281        |
| f | Bottom edge of sliding knob to floor | 40         |
| g | Closed floor clearance               | 72         |
| h | Underside of pedestal to floor       | 1-5 to 3.5 |
| j | Top edge of pedestal to floor        | 12         |
| k | Top of the top layer slab to floor   | 19.5       |
| m | Top of flange to floor               | 16         |
| n | Width of pedestal (inc. welded lugs) | 105        |

### Morton Marine & Commercial Parasols

Unit 1, Horseferry Bridge, Cirencester Road,  
Little Witcombe, Gloucester, GL3 4SU, UK

T: +44 (0)1452 865260

E: info@mortonparasols.com

W: www.mortonparasols.com (Commercial)

W: mortonparasols.co.uk (Residential)

W: marineparasols.co.uk (Marine)

page

14

***If in doubt - ask***



# Malaga Parasol Data *4.2m Octagonal on a pedestal + 50mm wheels*



Mast length: 260cm

Dimensions in cm

(Tolerance of +/- 5%)

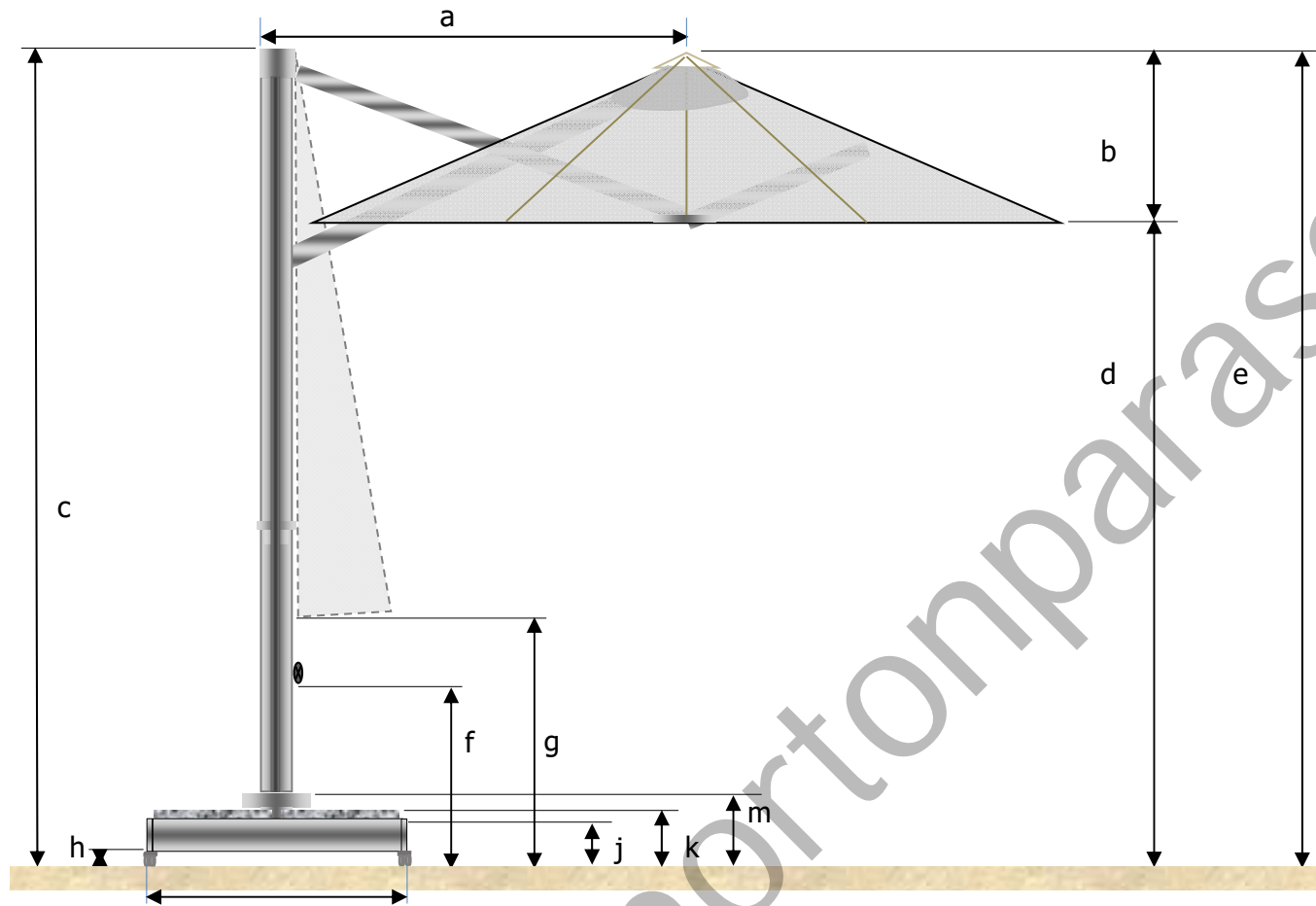

|   |                                      |      |
|---|--------------------------------------|------|
| a | Rear of mast to canopy centre        | 227  |
| b | Canopy depth                         | 70   |
| c | Overall height                       | 299  |
| d | Head room height                     | 237  |
| e | Apex of canopy to floor              | 286  |
| f | Bottom edge of sliding knob to floor | 44   |
| g | Closed floor clearance               | 77   |
| h | Underside of pedestal to floor       | 7    |
| j | Top edge of pedestal to floor        | 17   |
| k | Top of the top layer slab to floor   | 24.5 |
| m | Top of flange to floor               | 21   |
| n | Width of pedestal (inc. welded lugs) | 105  |

### Morton Marine & Commercial Parasols

Unit 1, Horseferry Bridge, Cirencester Road,  
Little Witcombe, Gloucester, GL3 4SU, UK

T: +44 (0)1452 865260

E: info@mortonparasols.com

W: www.mortonparasols.com (Commercial)

W: mortonparasols.co.uk (Residential)

W: marineparasols.co.uk (Marine)

page

15

***If in doubt - ask***

# Malaga Parasol Data *4.2m Octagonal on a pedestal + 75mm wheels*



Mast length: 260cm

Dimensions in cm

(Tolerance of +/- 5%)

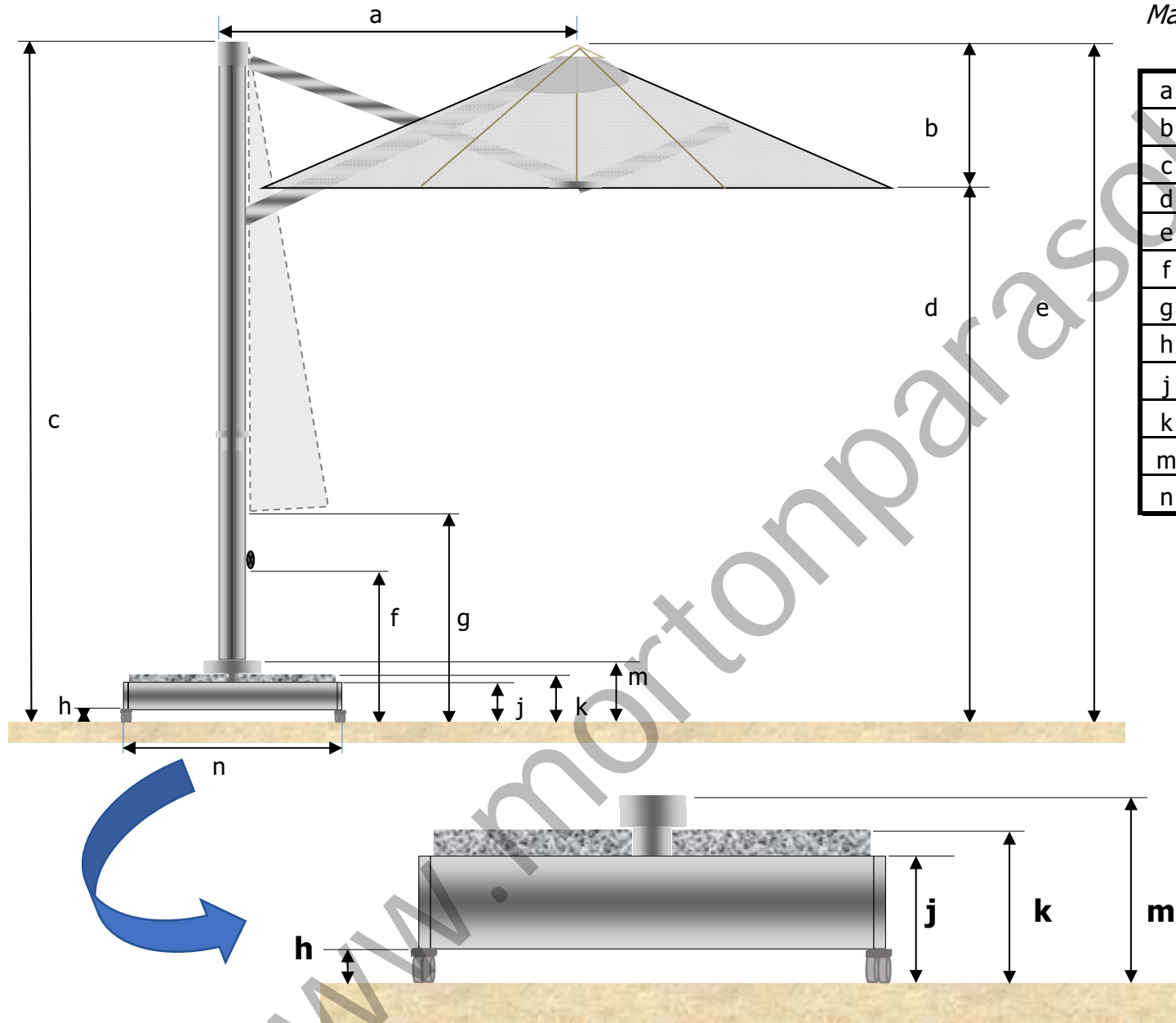

|   |                                      |      |
|---|--------------------------------------|------|
| a | Rear of mast to canopy centre        | 227  |
| b | Canopy depth                         | 70   |
| c | Overall height                       | 302  |
| d | Head room height                     | 240  |
| e | Apex of canopy to floor              | 289  |
| f | Bottom edge of sliding knob to floor | 48   |
| g | Closed floor clearance               | 80   |
| h | Underside of pedestal to floor       | 10   |
| j | Top edge of pedestal to floor        | 20   |
| k | Top of the top layer slab to floor   | 27.5 |
| m | Top of flange to floor               | 24   |
| n | Width of pedestal (inc. welded lugs) | 105  |

## Morton Marine & Commercial Parasols

Unit 1, Horseferry Bridge, Cirencester Road,  
Little Witcombe, Gloucester, GL3 4SU, UK

T: +44 (0)1452 865260

E: info@mortonparasols.com

W: www.mortonparasols.com (Commercial)

W: mortonparasols.co.uk (Residential)

W: marineparasols.co.uk (Marine)

page

16

***If in doubt - ask***